

TECHNICAL DATASHEET

Roxia Floating Aerator 11 kW (15 hp)

Roxia Floating Aerators are CE marked products from Finland.

Technical data

Oxygen transfer efficiency	Up to 2,0 kgO ₂ /kWh* (4.0 lbO ₂ /hp-hr)
Spray pattern diameter	Appr. 5,5 m (18 ft)
Motor	3-phase customized motor manufactured by Lönne or equal (CE, UL and CSA approved)
Nominal power	11 kW (15 hp)
Efficiency class	IE3
Insulation class	F
V/F	50 Hz: 400 V +- 5%, 21,5A; 60 Hz: 460V +- 5%, 21,5A
Electrical cable	4G10 European standard cable. Note: Length and local electrical control system may affect. When using AC-drive EMC-cable or shielded cable is required
Main dimensions	1950 mm x 1950 mm x 1400 mm (76,8" x 76,8" x 55,1")
Weight of aerator with floats	Appr. 310 kg (794 lb)
Materials	<ul style="list-style-type: none"> × Metals AISI 304 × Impeller alloyed special bronze × Float PE-plastic × Intake pipe** PE-plastic and stainless steel

Optional features

- Frequency converter (AC-drive)
 - × Protection class IP20 or IP66
 - × Automatic impeller cleaning cycle feature

Roxia Digital Solutions & Roxia Malibu™

Metal parts AISI 316

Intake pipe screen

Lifting frame

Shallow pond protect

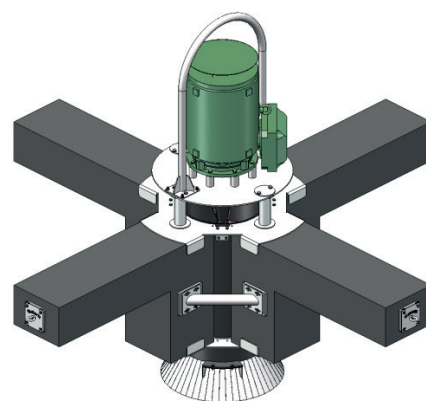

* Oxygen measurement accuracy ± 15%

** Customer must define the length of the intake pipe (the pipe should be 1,0 - 2,0 m / 3.3 - 6.6 ft above the bottom of the basin, depends on basins material).

Information without engagement. All rights to changes without prior notice reserved.